



Dakco LED Displays

www.dakco.cn

Genesis II

Outdoor LED Signs & Digital Billboards

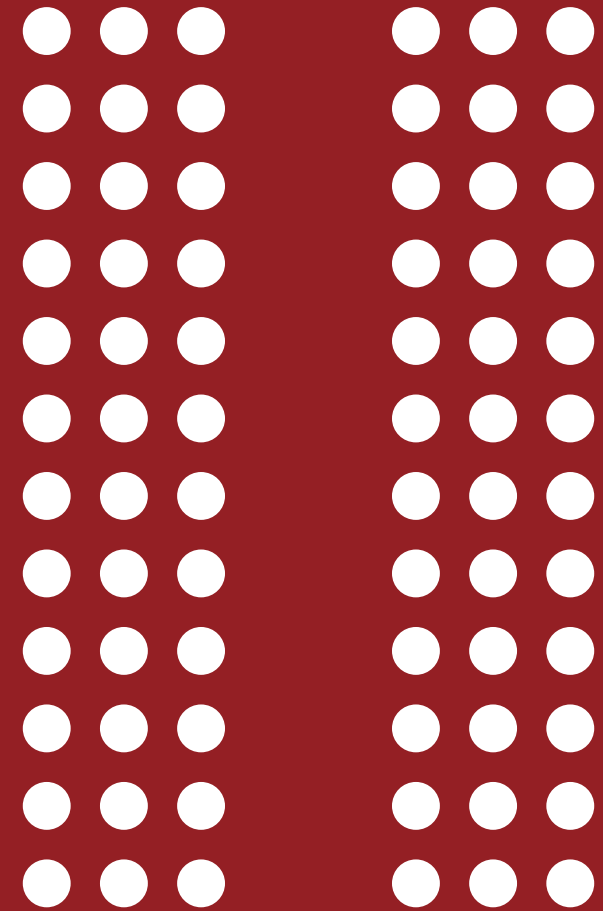

Dakco Technologies Co.,Ltd.

+86-755-2910-6150

sales@dakco.cn

Building #2, Nangang 3rd Industry Park, Tangtou Ave., Shiyan, Baoan, Shenzhen China



Brilliant Outdoor LED Signs Brighten Your Future!

Genesis II

The Genesis II is originally designed for the outdoor LED Signs & Digital Billboards with demanding requirements and standards in the USA. It is developed with the advanced techniques and processes, featuring more stunning visual displays, greater stability, and higher efficiency with the use of common cathode 3.8V. Through continuous testing and optimization with our professionals and technicians, it currently represents the industry's top-level outdoor LED display with a reasonable price. Today, customers of Dakco in more countries and regions could enjoy the exceptional performance and excellent efficiency of the Genesis II.

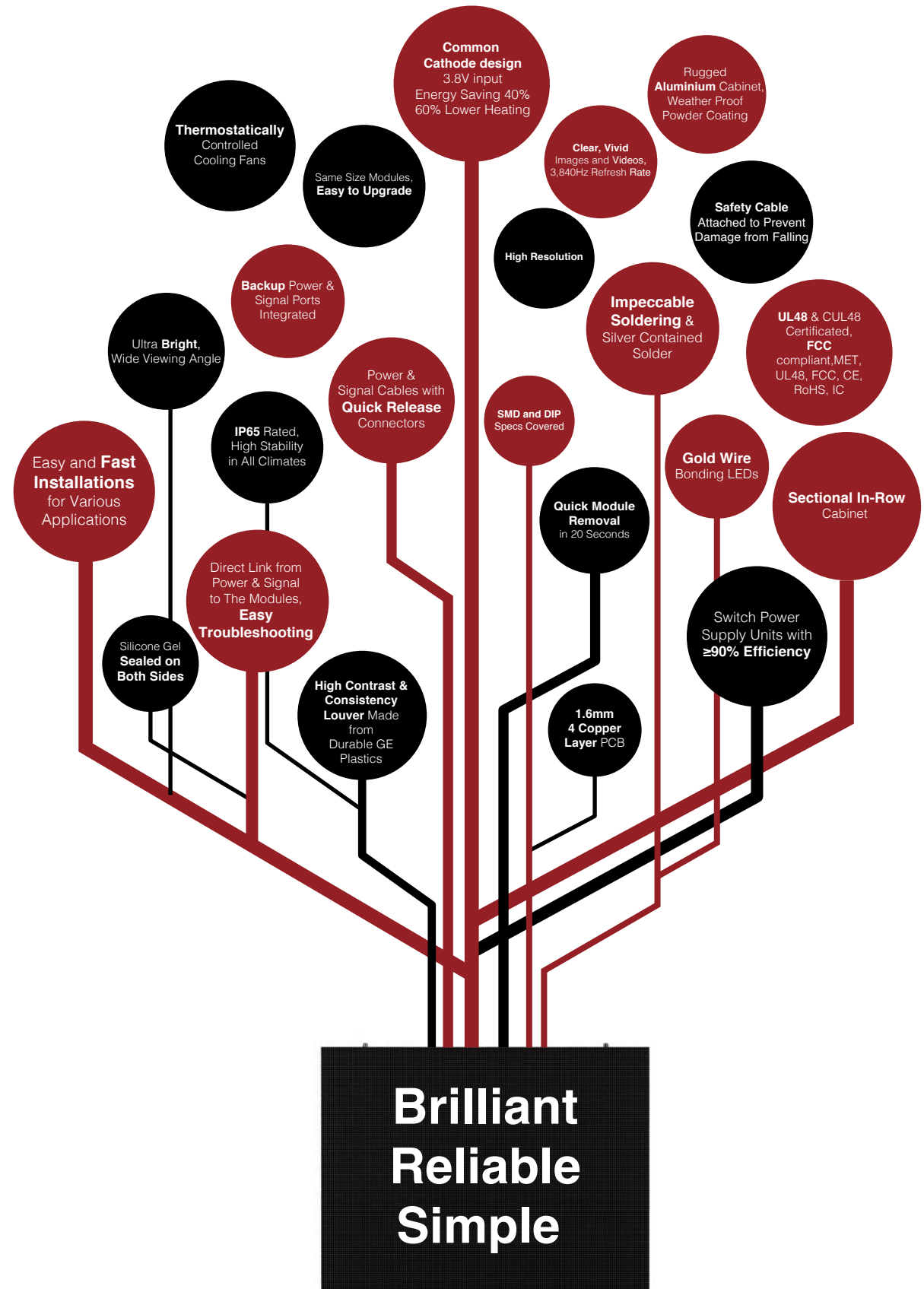
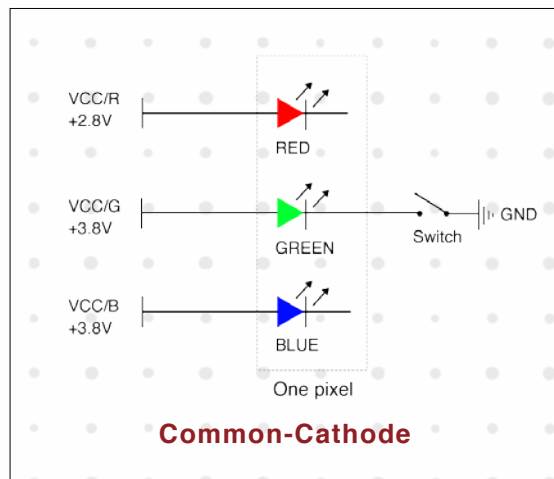



Brilliant



Ultra-Bright.

Equipped with over 6,500/10,000 Nits of brightness, the display is clearly visible even under direct and strong sunlight.



Vibrant.

With a fine pixel pitch starting from 3mm, 281 trillion colors, and a 3,840 Hz refresh rate, it delivers bright and vibrant colors, producing clear and vivid images and videos for the audiences.



Reachable from Wide Viewing Angles.

Wide 160° horizontal and 120° vertical viewing angles ensure your branding and advertising information reaches the potential target audience from any angle.

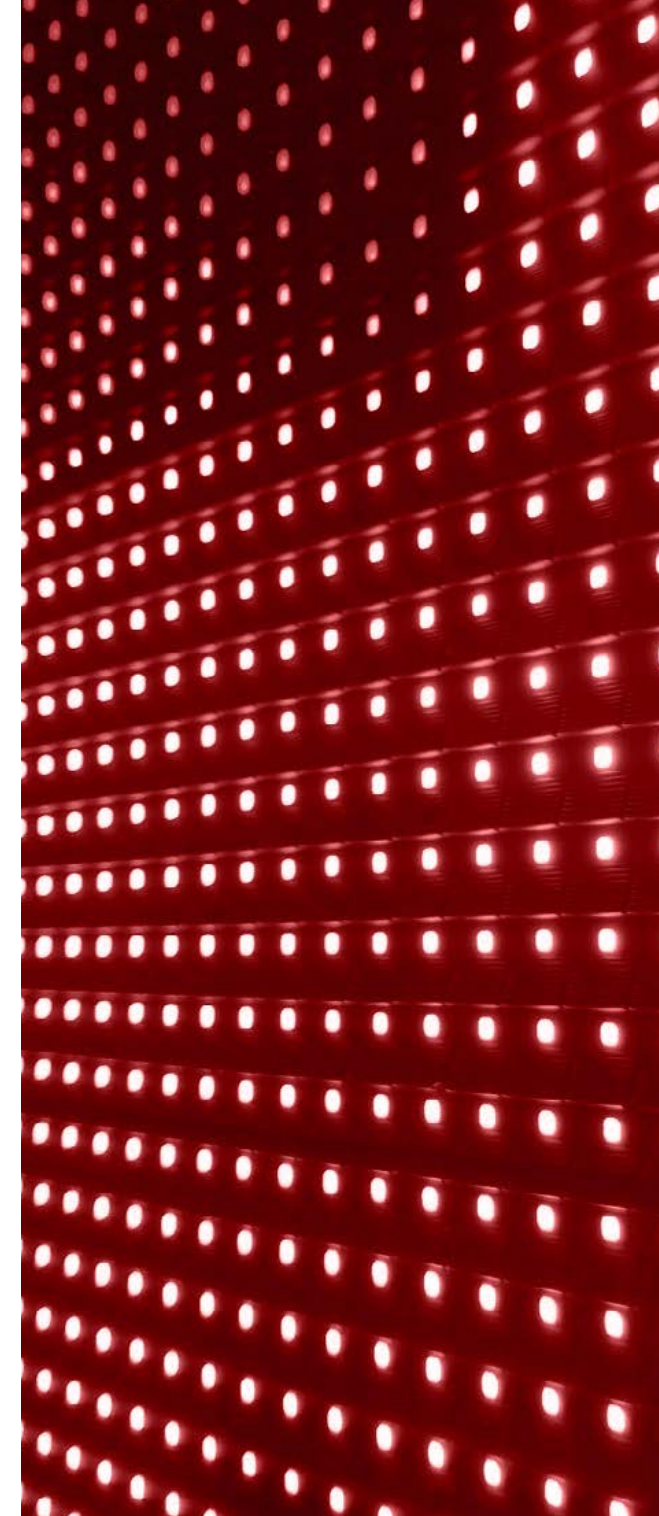

“

Multiple configurations can be used for different installations and scenarios, be it large or small.

”

Extremely High Reliability and Longevity

Solid materials are indispensable and fundamental in our display, which features 4 copper-layer PCBs, gold-wire bonding LEDs and gold-plated connectors.

Engineered with strict R&D process in designs for unexpected harsh weather resistance, along with high-end and effective thermal management, as well as the continuous testing and improvement over 5 years, Genesis II has showcased its strong reliability and trustworthy longevity.

**Silicone Gel sealed on both sides: Prevents oxidation of components and solder joints etc.*

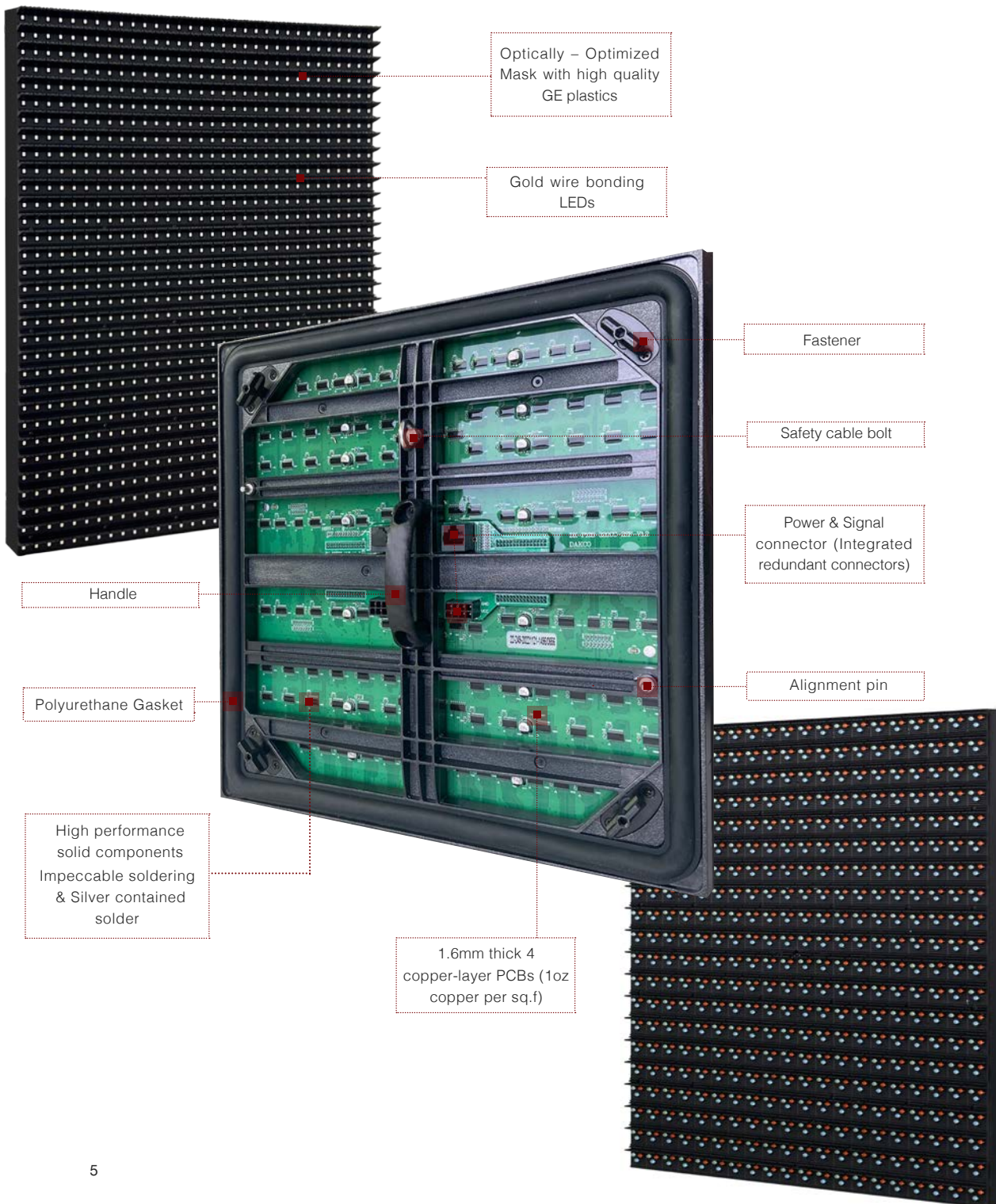

Trustworthy in All Sorts of Climates

The Genesis II aluminum cabinet is IP65 rated, ensuring the product is electrically functional and stable in all kinds of climates, including severe weather and extreme temperatures. Its efficient heat dissipation design enables durable and reliable performance.



Sectional In-Row Cabinet

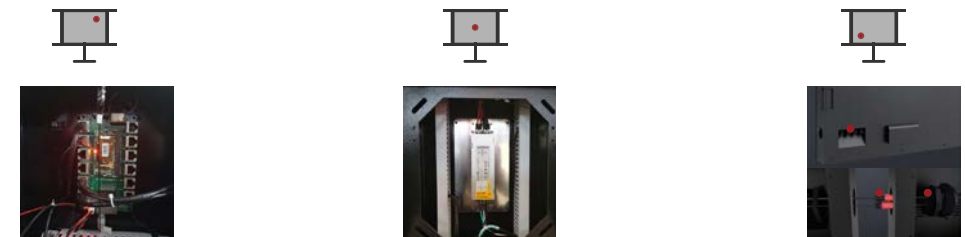

Receiving Card & Cooling Fans

High RPM cooling fans start working when the temperature hits 40°C/104°F (adjustable via software) and continue running until the temperature drops to 35°C/95°F, following the instruction of Dakco's smart thermostatic control system.

Switch Power Supplies

As a critical device in cabinet, the PSU is equipped with no cooling fans and thus will not draw in moisture & condensation, salt air, dust, and minerals to corrode internal components. Also, the efficiency of PSU has reached or even exceeded 90%.

Wiring

All wiring connections are conducted via robust and watertight grips, grommets, or connectors.

Options

Dakco has been involved and dedicated to the outdoor LED industry for more than ten years and has acquired lots of onsite experience from our projects in different countries and regions across the world. We are sure that we could meet all sorts of requirements from our customers and we are now ready to provide the options as follows for the customers:

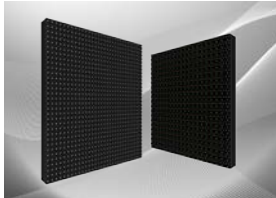

Metric and Imperial

Both Metric and Imperial versions are available for your options. The module size of Metric is 320mmx320mm, while that of Imperial is 12"x12".

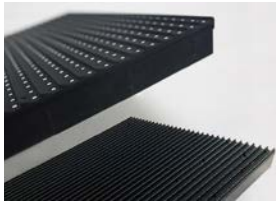

Standard and Long Louvers

We come with Standard Louver and Long Louver. Standard module louver enables to expand the viewing angle to the maximum, while long module louver plays a good role in shading under strong direct sunlight, thereby greatly improving the contrast of display.



Front and Back Ventilation

Both front ventilation and back ventilation are supported. In the circumstance where 3" gaps not achieved in the back ventilation in recessed installation, front ventilation is a perfect solution provided.

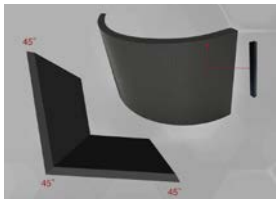

Flat, Right Angle, Arc, Special-shape Available

More shapes than you can imagine! With features of creative shapes and excellent consistency, it allows you to deliver any contents from different angles in different scenarios, which not only brings your idea to life, but also attracts more potential customers easily.



Different Budgets

Moreover, a basic version has been manufactured and is added to the Genesis II product lineup to exclusively meet the budget requirements in different countries & regions.



“

All Models Share The Same Plastic Housing - Retrofit & Upgrade Your Signs In Future With Less Time, Less Cost.

”

Specification - SMD Type

Pixel Pitch (Resolution)	3 mm New	4 mm New	6.67 mm	8 mm	10 mm
LED Package Type	SMD (Black)	SMD (Black)	SMD	SMD	SMD
Pixels Per Sq.m (Density)	104,329	62,500	22,500	15,625	10,000
Module Dimensions	12.6"x12.6" (320mm x 320mm)	12.6"x12.6" (320mm x 320mm)	12.6"x12.6" (320mm x 320mm)	12.6"x12.6" (320mmx320mm)	12.6"x12.6" (320mmx320mm)
Module Matrix	104x104	80x80	48x48	40x40	32x32
Module Weight	3 LB (1.4 KG)	3 LB (1.4 KG)	3 LB (1.4 KG)	3 LB (1.4 KG)	3 LB (1.4 KG)
Driving Method	1/13 constant current	1/10 constant current	1/6 constant current	1/4 constant current	1/2 constant current
Refresh Rate	≥3,840 Hz	≥3,840 Hz	≥1,920 / 3,840 Hz	≥1,920 / 3,840 Hz	≥1,920 / 3,840 Hz
Video Frame Rate	60 frames/second	60 frames/second	60 frames/second	60 frames/second	60 frames/second
Grayscale	65,536 (281 trillion colors)	65,536 (281 trillion colors)	65,536 (281 trillion colors)	65,536 (281 trillion colors)	65,536 (281 trillion colors)
Color Depth	16 bit	16 bit	16 bit	16 bit	16 bit
Brightness (NITS)	≥3,500	≥4,500	≥6,500 / 10,000	≥6,500 / 10,000	≥6,500 / 10,000
Brightness Control	256 levels	256 levels	256 levels	256 levels	256 levels
Ideal Viewing Range	10' or greater	13' or greater	18' or greater	22' or greater	28' or greater
Ideal Viewing Angle	160°(H) / 120°(V)	160°(H) / 120°(V)	160°(H) / 120°(V)	160°(H) / 120°(V)	160°(H) / 120°(V)
Max. Power Consumption	74W/ft ² (800W/m ²)	74W/ft ² (800W/m ²)	56W/ft ² (600W/m ²)	56W/ft ² (600W/m ²)	56W/ft ² (600W/m ²)
Avg. Power consumption	24W/ft ² (260W/m ²)	24W/ft ² (260W/m ²)	18W/ft ² (200W/m ²)	18W/ft ² (200W/m ²)	18W/ft ² (200W/m ²)
Input Voltage	88 ~ 264VAC	88 ~ 264VAC	88 ~ 264VAC	88 ~ 264VAC	88 ~ 264VAC
Ingress Protection	IP65	IP65	IP65	IP65	IP65
Operating Temperature	-40 °F - +140°F (-40 °C - +60 °C)	-40 °F - +140°F (-40 °C - +60 °C)	-40 °F - +140°F (-40 °C - +60 °C)	-40 °F - +140°F (-40 °C - +60 °C)	-40 °F - +140°F (-40 °C - +60 °C)
MTBF	>5,000 hours	>5,000 hours	>5,000 hours	>5,000 hours	>5,000 hours
LED Life - Span	100,000 hours	100,000 hours	100,000 hours	100,000 hours	100,000 hours
Cabinet Size	Customized	Customized	Customized	Customized	Customized
Cabinet Material	Aluminum	Aluminum	Aluminum	Aluminum	Aluminum
Cabinet Weight	7.78 LB/ft ² (38 KG/m ²)	7.78 LB/ft ² (38 KG/m ²)	7.78 LB/ft ² (38 KG/m ²)	7.78 LB/ft ² (38 KG/m ²)	7.78 LB/ft ² (38 KG/m ²)

► For more information about our products with P4 and P3, please contact our sales team via sales@dakco.cn.

Specification - DIP Type

Pixel Pitch (Resolution)	10 mm	13.3 mm	16 mm
LED Package Type	DIP	DIP	DIP
Pixels Per Sq.m (Density)	10,000	5,652	3,906
Module Dimensions	12.6"x12.6" (320mm x 320mm)	12.6"x12.6" (320mmx320mm)	12.6"x12.6" (320mmx320mm)
Module Matrix	32x32	24x24	20x20
Module Weight	4.5 LB (2 KG)	4.5 LB (2 KG)	4.5 LB (2 KG)
Driving Method	1/4 constant current	1/2 constant current	Static
Refresh Rate	≥1,920 / 3,840 Hz	≥1,920 / 3,840 Hz	≥1,920 / 3,840 Hz
Video Frame Rate	60 frames/second	60 frames/second	60 frames/second
Grayscale	65,536 (281 trillion colors)	65,536 (281 trillion colors)	65,536 (281 trillion colors)
Color Depth	16 bit	16 bit	16 bit
Brightness (NITS)	≥10,000	≥10,000	≥10,000
Brightness Control	256 levels	256 levels	256 levels
Ideal Viewing Range	28' or greater	42' or greater	52' or greater
Ideal Viewing Angle	120°(H) / 60°(V)	120°(H) / 60°(V)	120°(H) / 60°(V)
Max. Power Consumption	35W/ft ² (380W/m ²)	35W/ft ² (380W/m ²)	35W/ft ² (380W/m ²)
Avg. Power consumption	11W/ft ² (120W/m ²)	11W/ft ² (120W/m ²)	11W/ft ² (120W/m ²)
Input Voltage	88 ~ 264VAC	88 ~ 264VAC	88 ~ 264VAC
Ingress Protection	IP65	IP65	IP65
Operating Temperature	-40 °F - +140°F (-40 °C - +60 °C)	-40 °F - +140°F (-40 °C - +60 °C)	-40 °F - +140°F (-40 °C - +60 °C)
MTBF	>5,000 hours	>5,000 hours	>5,000 hours
LED Life - Span	100,000 hours	100,000 hours	100,000 hours
Cabinet Size	Customized	Customized	Customized
Cabinet Material	Aluminum	Aluminum	Aluminum
Cabinet Weight	9 LB/ft ² (45 KG/m ²)	9 LB/ft ² (45 KG/m ²)	9 LB/ft ² (45 KG/m ²)

Simplicity

The internal components of the display can be accessed easily from the front, with a 1/4 turn of 4 hex fasteners located at the corners of each module. It will take only 20 seconds to disassemble and remove one module.

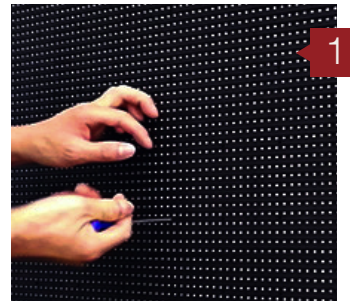
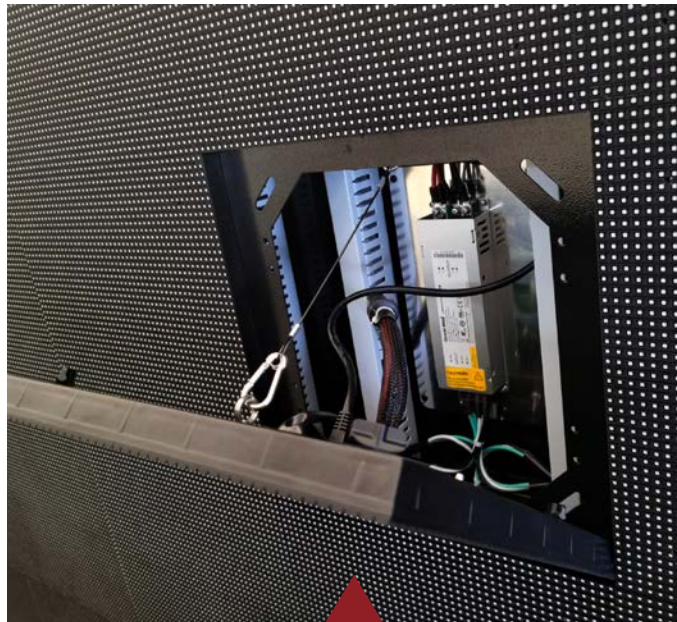

“

Safety cable is attached between the module and cabinet to prevent any unexpected and sudden damages, like falling down due to uncontrollable factors when working in some special scenarios.

”

- ▶ Signal transmission to each module is separately operated, improving the screen's visual performance and simplifying the troubleshooting process.

FCC INTERFERENCE STATEMENT

Federal Communications Commission Interference Statement

This device complies with part 15 of the FCC Rules. Operation is subject to the following two conditions: (1) This device may not cause harmful interference, and (2) this device must accept any interference received, including interference that may cause undesired operation.

This equipment has been tested and found to comply with the limits for a Class B digital device, pursuant to part 15 of the FCC Rules. These limits are designed to provide reasonable protection against harmful interference in a residential installation. This equipment generates, uses and can radiate radio frequency energy and, if not installed and used in accordance with the instructions, may cause harmful interference to radio communications. However, there is no guarantee that interference will not occur in a particular installation. If this equipment does cause harmful interference to radio or television reception, which can be determined by turning the equipment off and on, the user is encouraged to try to correct the interference by one or more of the following measures:

- Reorient or relocate the receiving antenna.
- Increase the separation between the equipment and receiver.
- Connect the equipment into an outlet on a circuit different from that to which the receiver is connected.
- Consult the dealer or an experienced radio/TV technician for help.

FCC Caution: Any changes or modifications not expressly approved by the party responsible for compliance could void the user's authority to operate this equipment.

Import & Freight

We offer the most competitive shipping rates, and we take all the hassle out of importing.

To shorten the delivery time of customers, we keep materials in stock ready for immediate production in our Shenzhen plant. Dakco is equipped with highly efficient inventory management and comprehensive logistics services, thus the delivery time of our LED products is guaranteed.

We can also ship your order immediately in the U.S.!

Dakco has a large stock of fully assembled and tested Genesis product line-up in multiple locations in the U.S.. Therefore, it guarantees the on-time delivery of our products before the deadline to meet your needs.



“

Everything we do is for your convenience!

”